



# Cambridge IGCSE™

CANDIDATE  
NAME

CENTRE  
NUMBER

--	--	--	--	--

CANDIDATE  
NUMBER

--	--	--	--



**PHYSICS**

**0625/63**

Paper 6 Alternative to Practical

**October/November 2023**

**1 hour**

You must answer on the question paper.

No additional materials are needed.

## INSTRUCTIONS

- Answer **all** questions.
- Use a black or dark blue pen. You may use an HB pencil for any diagrams or graphs.
- Write your name, centre number and candidate number in the boxes at the top of the page.
- Write your answer to each question in the space provided.
- Do **not** use an erasable pen or correction fluid.
- Do **not** write on any bar codes.
- You may use a calculator.
- You should show all your working and use appropriate units.

## INFORMATION

- The total mark for this paper is 40.
- The number of marks for each question or part question is shown in brackets [ ].

This document has **12** pages.

- 1 Sand is a granular material composed of very small, irregularly-shaped mineral particles. A student determines the density of sand by two methods.

She uses the apparatus shown in Fig. 1.1 and Fig. 1.2.

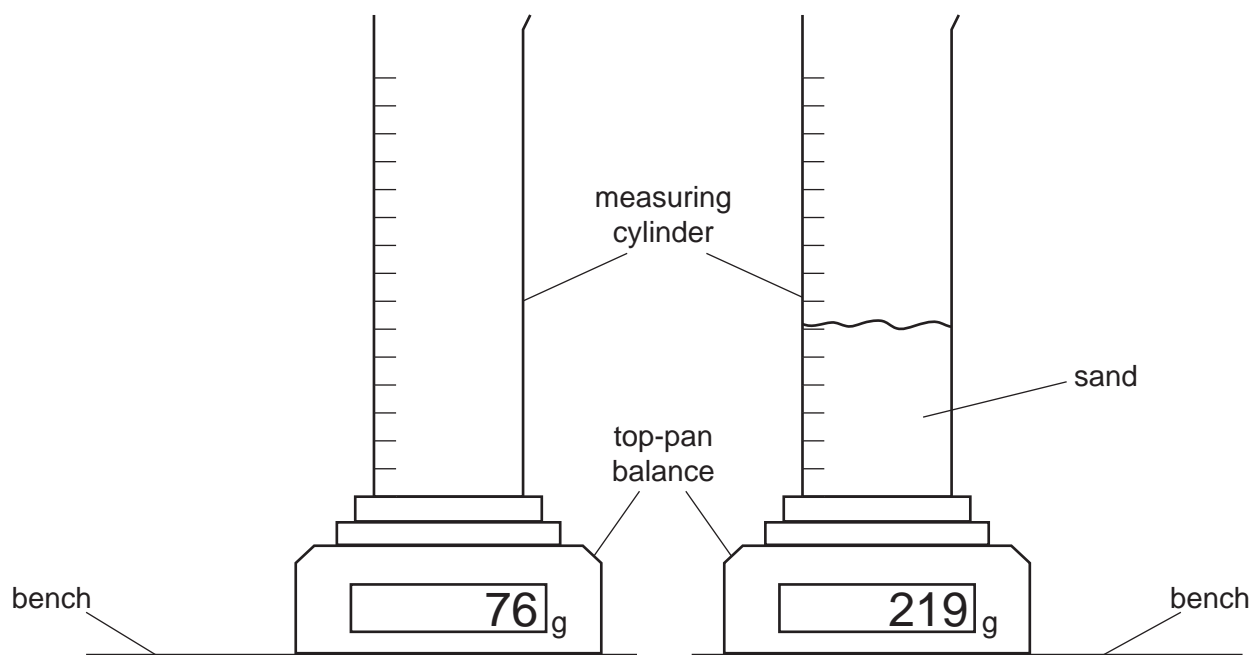

Fig. 1.1

Fig. 1.2

### Method 1

- (a) (i) The student measures the mass of a  $250 \text{ cm}^3$  measuring cylinder, as shown in Fig. 1.1.

She pours sand into the measuring cylinder and measures the mass of the measuring cylinder and sand, as shown in Fig. 1.2.

Use the values shown in Fig. 1.1 and Fig. 1.2 to calculate the mass  $m$  of the sand.

$$m = \dots\dots\dots \text{ g [1]}$$

- (ii) The student measures the volume  $V_1$  of the sand in the measuring cylinder.

$$V_1 = \dots\dots\dots 108 \dots\dots\dots \text{ cm}^3$$

Calculate a value for the density  $\rho_1$  of the sand sample. Use the values from (a)(i) and the equation  $\rho_1 = \frac{m}{V_1}$ . Include a unit.

$$\rho_1 = \dots\dots\dots \text{ [2]}$$

## Method 2

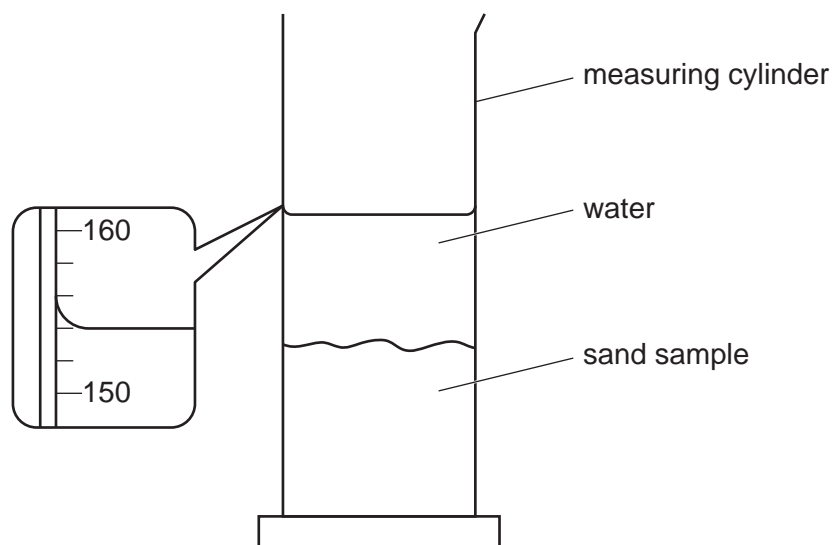

Fig. 1.3

- (b) (i) The student pours  $100 \text{ cm}^3$  of water into the measuring cylinder containing the sample of sand.  
Some of the water soaks into the sand sample and she waits for the water level to become constant.

Record the reading  $V_2$  of the water level in the measuring cylinder shown in Fig. 1.3.

$$V_2 = \dots\dots\dots \text{ cm}^3 \quad [1]$$

- (ii) Calculate another value for the density  $\rho_2$  of the sand sample.

Use the values from (a)(i) and (b)(i) and the equation  $\rho_2 = \frac{m}{(V_2 - k)}$ , where  $k = 100 \text{ cm}^3$ .

$$\rho_2 = \dots\dots\dots \quad [2]$$

(iii)

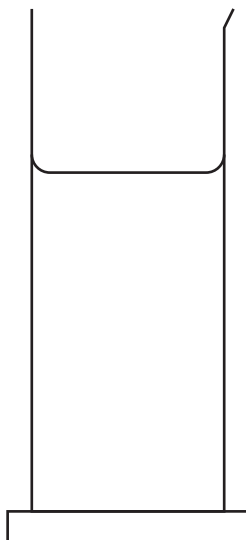

Fig. 1.4

On Fig. 1.4, draw an arrow showing the correct line of sight for reading the volume of water in the measuring cylinder. [1]

(c) Another student wants to determine the density of the particles in a similar sample of sand.

(i) Explain why **method 1** would **not** be a suitable method for him to use.

.....  
..... [1]

(ii) Explain why **method 2** would give a more accurate value for the density **of the particles** in this sample of sand.

.....  
..... [1]

(d) Describe **two** possible sources of inaccuracy in the measurements taken in **method 1** or **method 2**, even if they are carried out carefully.

1 .....  
.....

2 .....  
.....

[2]

[Total: 11]

- 2 A student investigates the cooling of hot water in surroundings with different temperatures. He uses the apparatus shown in Fig. 2.1.

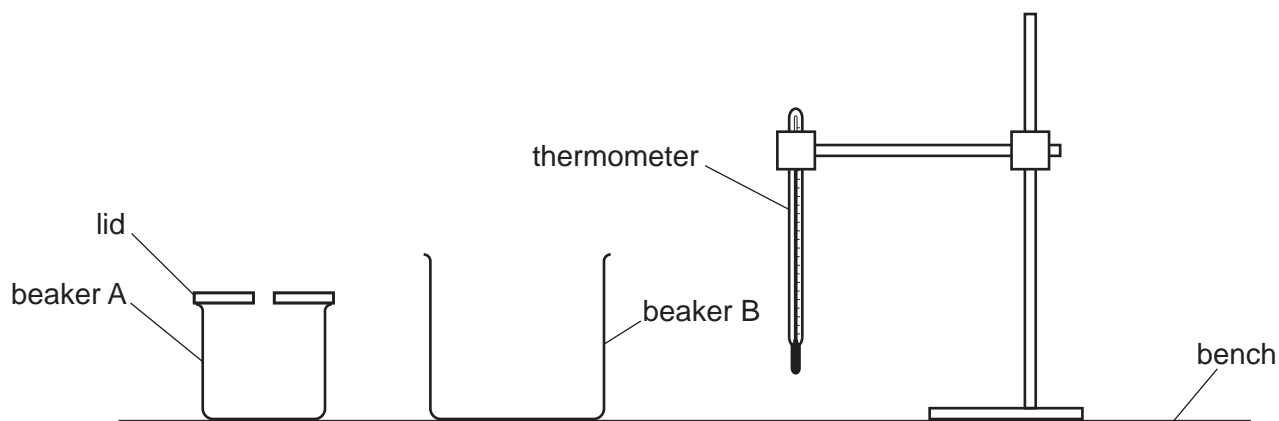

Fig. 2.1

- (a) The student pours  $100\text{ cm}^3$  of cold water into beaker B and places the thermometer in the water. Measure, and record in the appropriate column heading of Table 2.1, the temperature  $\theta_1$  of the water, as shown in Fig. 2.2.

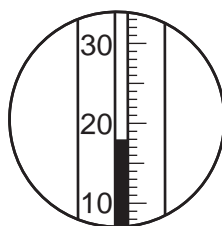

Fig. 2.2

[1]

- (b) The student places beaker A inside beaker B as shown in Fig. 2.3 so that the water in beaker B rises between the sides of the two beakers.

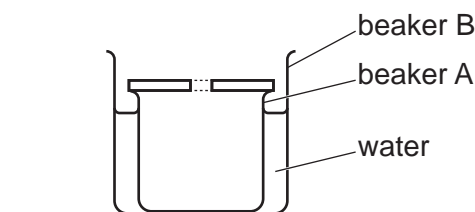

Fig. 2.3

He removes the lid and pours  $150\text{ cm}^3$  of hot water into beaker A. He replaces the lid and puts the thermometer into the hot water in beaker A. He records, in Table 2.1, the temperature  $\theta_A$  of the water every 30s.

Describe **one** precaution that can be taken to ensure that the temperature readings are as accurate as possible.

.....

..... [1]

- (c) The student repeats the process for water at a higher temperature  $\theta_2$  in beaker B. His readings are shown in Table 2.1.

Table 2.1

	beaker A in <b>cold</b> water $\theta_1 = \dots\dots\dots^\circ\text{C}$	beaker A in <b>warm</b> water $\theta_2 = \dots\dots\dots 48 \dots\dots\dots^\circ\text{C}$
$t/\text{s}$	$\theta_A/^\circ\text{C}$	$\theta_A/^\circ\text{C}$
0	78.5	80.0
30	72.5	77.0
60	69.0	74.5
90	66.5	73.0
120	65.0	71.5
150	63.5	70.5
180	62.0	70.0

Write a conclusion stating in what way the temperature of the water surrounding beaker A affects the rate of cooling of the hot water in beaker A. Justify your answer by reference to values from the readings.

.....

.....

.....

..... [2]

- (d) Calculate the average cooling rate  $R$  for beaker A cooling in **cold** water. Use the readings for beaker A from Table 2.1 and the equation

$$R = \frac{\theta_{A0} - \theta_{A180}}{T}$$

where  $T = 180\text{s}$  and  $\theta_{A0}$  and  $\theta_{A180}$  are the temperatures of the water in beaker A at  $t = 0$  and  $t = 180\text{s}$ . Include the unit for the cooling rate.

$$R = \dots\dots\dots [2]$$

- (e) Another student repeats this experiment at the same room temperature.

State **two** other variables that she controls in order to obtain readings as close as possible to the readings in Table 2.1.

1 .....

.....

2 .....

.....

[2]

- (f) After 180s, the student measures the temperature of the water surrounding beaker A in the first experiment and finds that  $\theta_1 = 49^\circ\text{C}$ .

- (i) State the reason why this can affect the results of the investigation and suggest what effect it has on the value of cooling rate  $R$ .

reason .....

.....

effect on  $R$  .....

.....

[2]

- (ii) Suggest **one** change to the experiment to reduce the effect in (f)(i).

.....

.....

.....[1]

[Total: 11]

3 A student determines the focal length of a converging lens.

She uses the apparatus shown in Fig. 3.1.

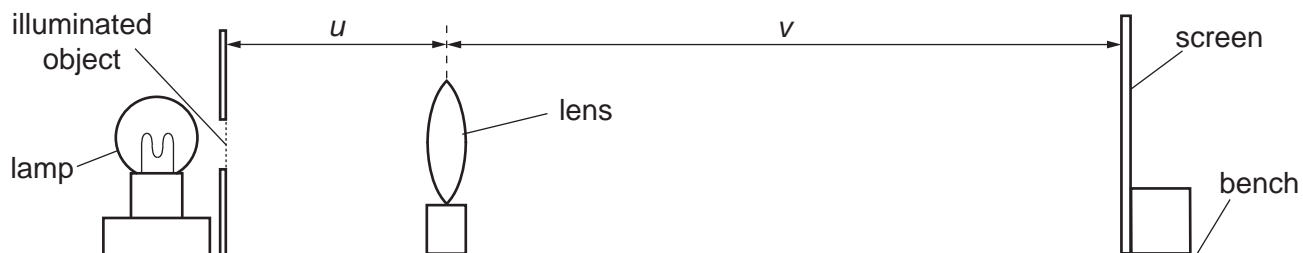

**Fig. 3.1**

- (a) The student sets the distance  $u$  between the illuminated object and the lens to 20.0 cm. She moves the screen until a sharp image of the illuminated object is seen on the screen. She then measures, and records in Table 3.1, the distance  $v$  between the lens and the screen.

Describe a technique to obtain an image on the screen that is as sharp as possible in this experiment.

Include in your description:

- where the screen should be placed initially
- how an accurate position for the sharp image is obtained.

.....

.....

.....

..... [2]



- (b) The student repeats the procedure for  $u = 30.0$  cm,  $40.0$  cm,  $50.0$  cm and  $60.0$  cm. Her readings are shown in Table 3.1.

**Table 3.1**

$u/\text{cm}$	$v/\text{cm}$	$\frac{u}{v}$
20.0	60.0	
30.0	27.3	1.10
40.0	25.8	1.55
50.0	21.4	2.34
60.0	20.0	3.00

For distance  $u = 20.0$  cm, calculate, and record in Table 3.1, the value of  $\frac{u}{v}$ . [1]

- (c) Plot a graph of  $u/\text{cm}$  ( $y$ -axis) against  $\frac{u}{v}$  ( $x$ -axis). Start your graph at the origin (0,0).

Draw the best-fit line.

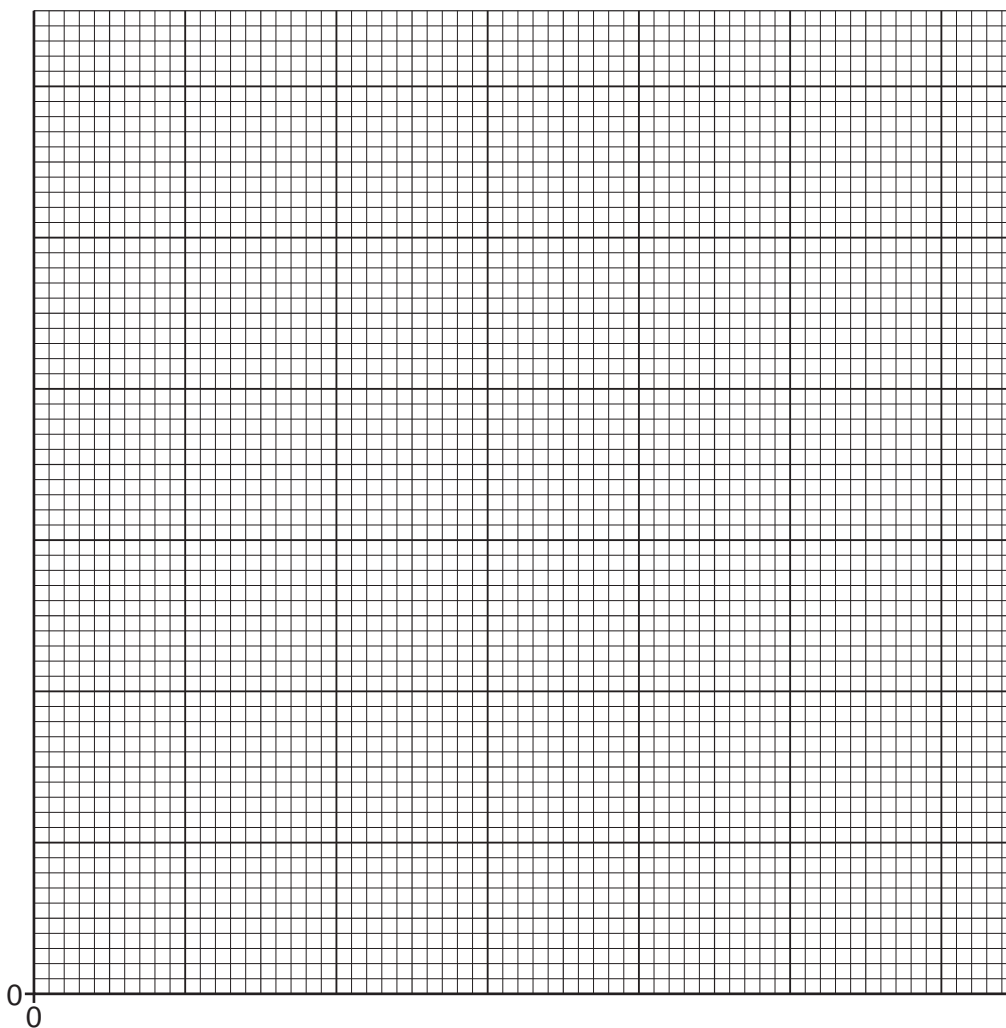

[4]

10

- (d) (i) Determine the value  $u_0$  of  $u$  when  $\frac{u}{v} = 0$ .

$$u_0 = \dots\dots\dots [1]$$

- (ii) The gradient of the graph is numerically equal to the focal length  $f$  of the lens.

Determine the value of  $f$  for this experiment.

Show clearly on the graph how you obtained the necessary information to determine the gradient.

$$f = \dots\dots\dots [2]$$

- (e) Suggest **one** precaution that can be taken to ensure measurements are accurate in this experiment.

.....  
..... [1]

[Total: 11]

- 4 A student investigates the brightness of a lamp.

Plan an experiment to investigate how the intensity (brightness) of the light produced by the lamp is affected by the current in the lamp.

The apparatus available includes:

- a lamp and power supply
- a light meter which measures the intensity of light arriving at it
- an ammeter
- a variable resistor.

In your plan, you should:

- complete the circuit diagram in Fig. 4.1 to show the variable resistor connected to control the current in the lamp
- state the key variables to be kept constant
- explain briefly how to do the experiment
- draw a table with column headings, to show how to display the readings (you are **not** required to enter any readings in the table)
- explain how to use the readings to reach a conclusion.

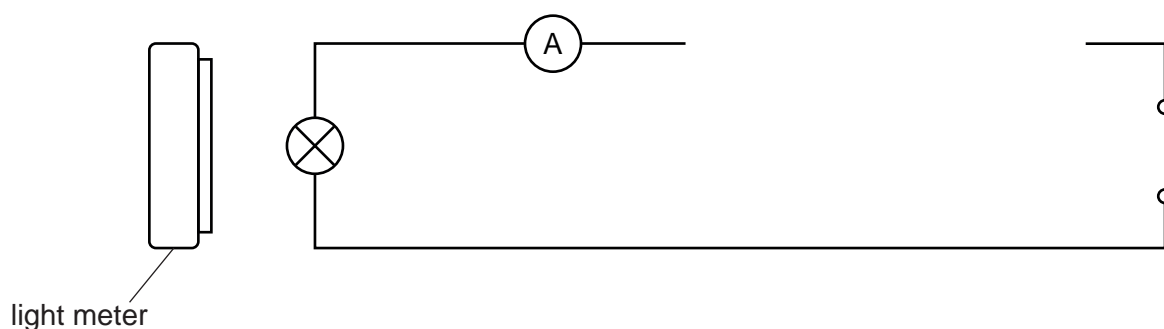

Fig. 4.1

